

Easyrig Vario 5

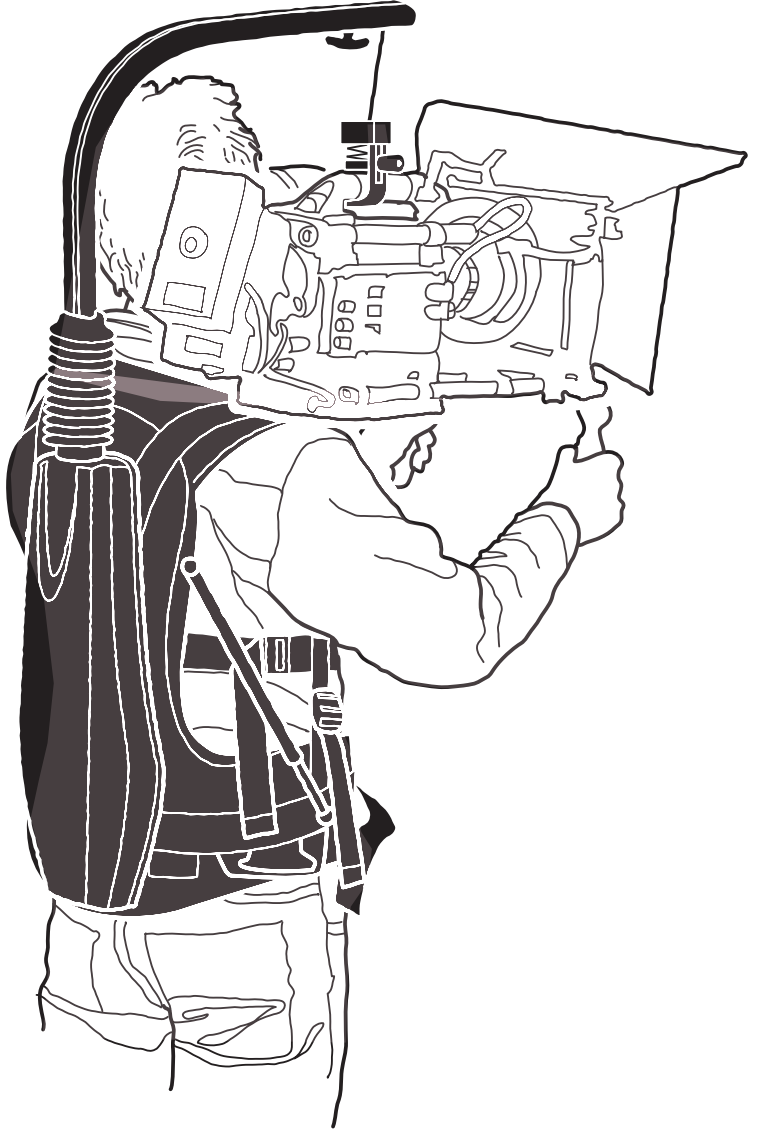

User Manual

Setup and Adjustment

Easyrig VARIO 5 Specifications

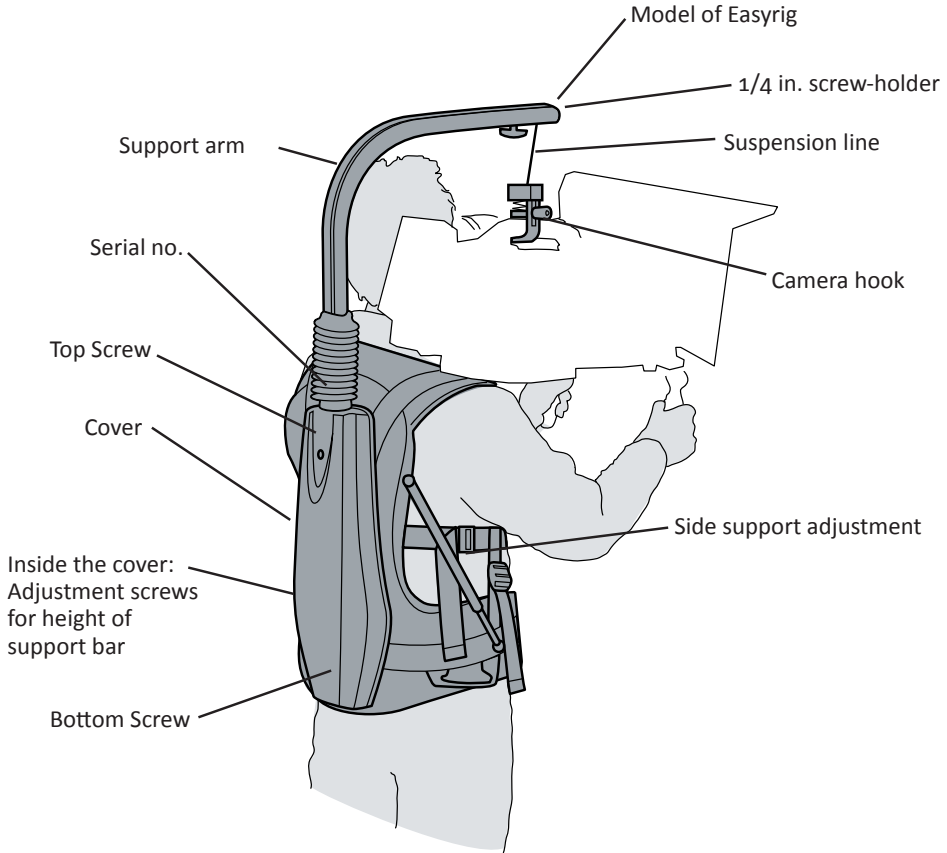

Weight complete with 2,5 vest adjustable arm +130	4,7 kg (9 lbs)
Weight complete with Cine 3 vest adjustable arm +130	5,2 kg (11 lbs)
Weight complete with Gimble vest adjustable arm +130	5,5 kg (12 lbs)
Height (mounted)	97–114 cm (38–45 in)
Height (folded)	60 cm (24 in)
Suspension line (fully stretched)	90 cm (35 in)
Load range	5-17 kg (11-38 lbs)

Designed and made in Sweden - www.easyrig.com

Congratulations on your new Easyrig VARIO 5!

The Easyrig VARIO 5 has an adjustable weight range from 5-17kg (11-38 lbs). By turning the adjustment screw located on the back, you can easily change the tension / power of the line.

The Easyrig VARIO 5 gives you the same advantages as our other Easyrig models with the added benefit of being able to adjust the line tension to adapt to many different cameras and configurations. The Easyrig VARIO 5 still delivers the same steady hand held shots while relieving you back, neck and shoulders. The load is redistributed to the hips allowing you to shoot hand held in comfort for hours.

The Easyrig VARIO 5 will be your best tool when it comes to hand-held shooting for Movies, Commercials, Television and any other situation where stability and freedom of movement are crucial.

The Easyrig VARIO 5 is manufactured in Sweden and is built to the highest standards. The Easyrig VARIO 5 is ergonomically designed and field tested to achieve maximum results.

To get the most out of your Easyrig VARIO 5, please read this user manual carefully.

Thank you for your investment in the Easyrig VARIO 5.

Good Luck!

Cameraman and
Inventor of Easyrig



Johan Hellsten

Using the Easyrig VARIO 5

It's easy to get into the Easyrig VARIO 5 vest, just as with a backpack. Your Easyrig VARIO 5 is loaded with adjustments for your customized comfort.

When the vest is adjusted properly you should feel the weight of the camera primarily on your hips. It is also important that the support bar is vertical. If not, the load will be unevenly distributed on the hips causing the camera to possibly contact the bar.

The waist belt adjustment should be tightened so that the vest doesn't slide down around the hips but sits firmly on the hips. The shoulder straps are mainly for support and balancing the Easyrig. They prevent it from tilting.

When attaching the hook onto the camera, you might find it easier to set the camera on a table or a bench first. Try and find the balancing point of the camera then secure the hook at that point on the handle and tighten the lock on the camera hook.

Don't forget to fasten the safety line between the camera handle and the vest.

Shooting from the Hip

The Easyrig VARIO 5 gives you the freedom to shoot at various height levels, from the shoulder to the waist by simply moving the camera down from your shoulder. You should feel only a fraction of the camera's weight.

When shooting at hip level, lean slightly backwards while pushing the camera forward. This will minimize the load on your back. The length of the suspension line makes it possible to position the camera as far as your arms can reach.

Getting started with the Easyrig VARIO 5

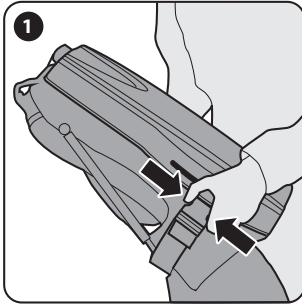

Fig. 1

Unlatch the buckle and unfold the support arm.



Fig. 2

Let the tube attached to the support arm slide into the lower tube section and pull over the bellows.



Fig. 3

With the Easyrig VARIO 5 firmly sitting on ground, attach the camera to the hook. Check to make sure the camera is supported properly.

- If the tension is incorrect to support your camera weight, continue to step 4a.
- If the tension is correct to support your camera weight, continue to step 6.

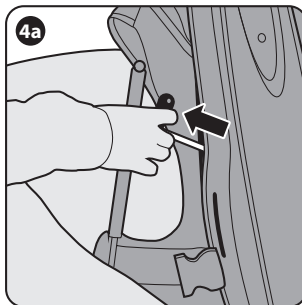

Fig. 4

Locate the adjustment Allen-key 6mm tool behind the Easyrig VARIO 5 cover and pull it out.

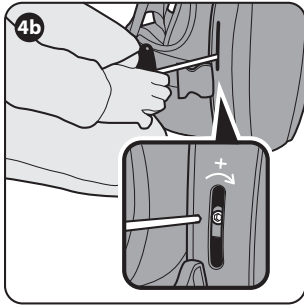

Fig. 4b

You can adjust the line tension for different camera weights by using the 6mm adjustment tool. Turn clockwise to add more tension to the line or counterclockwise to reduce the amount of tension. The faster the camera descends, the more weight there will be on your shoulder, (less line tension.) Observe, the adjustment tool will move as the line is pulled down. Remember, “righty tighty, lefty loosy.”

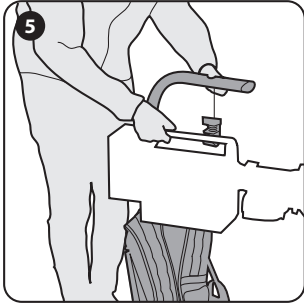

Fig. 5

Check again to make sure your camera is supported properly. Repeat step 4b if necessary.



Fig. 6

Put on your Easyrig VARIO 5 vest. Adjust the waist belt snugly to ensure the weight sits firmly on your hips. Then set the other vest adjustments to make sure your Easyrig VARIO 5 is comfortable and gives you the proper amount of support.

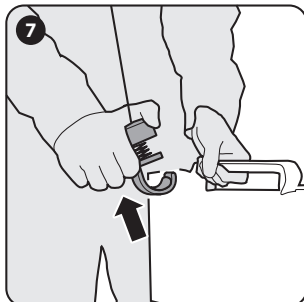

Fig. 7

Attach your camera to the Easyrig VARIO 5 hook. Loosen the lock knob and use your middle finger to open the hook. Once attached to your camera handle, secure the hook by turning the lock knob clockwise.

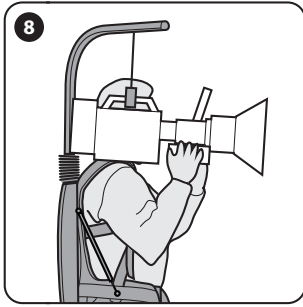

Fig. 8

Make sure your Easyrig VARIO 5 feels comfortable and that the support arm is in a good vertical position, not too high or too low.

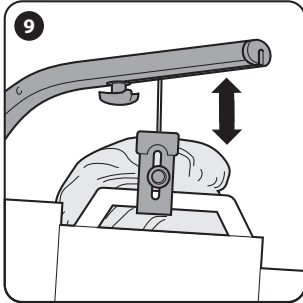

Fig. 9

Leave a gap of approximately 2-15 cm (1-6 inches) between the top of the camera hook and the support arm.

- If there is a need for adjustment, continue to step 10 or 12b.
- If everything is correct, continue to step 13.

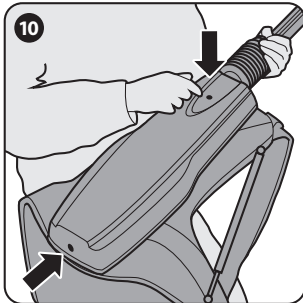

Fig. 10

Adjust the height of the support arm by removing the Easyrig VARIO 5 cover located on the back of your Easyrig VARIO 5. Locate the two cover screws and unscrew them with the 6mm Allen-key to remove the cover.

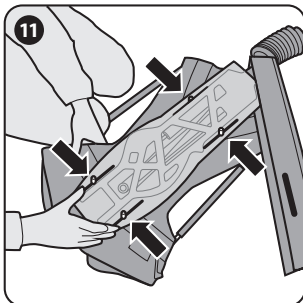

Fig. 11

Using the same 6mm Allen-key, locate and loosen the four adjustment screws on the Easyrig VARIO 5 mechanism.

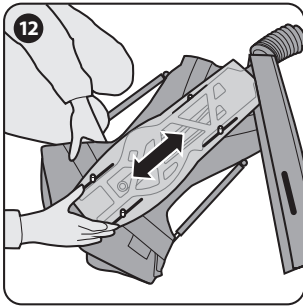

Fig. 12

Adjust the support arm height by sliding the entire mechanism up or down to find the correct position. Then, tighten the four adjustment screws with the 6mm Allen-key. Replace the cover and tighten the cover screws.

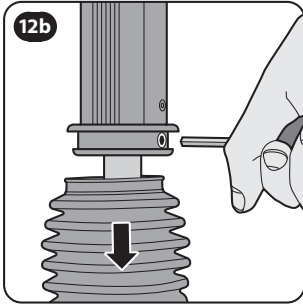

Fig. 12B

If more adjustments is required, you can also change the position of the 20 mm tube inside the support arm at it's base under the bellows.

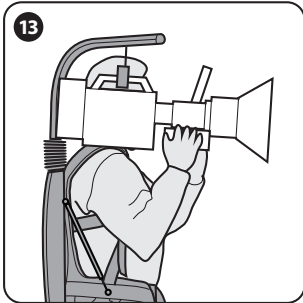

Fig. 13

The Easyrig VARIO 5 support arm is now in the correct position.

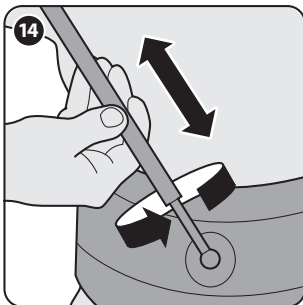

Fig. 14

By twisting the side support arm you can shorten or lengthen them to adjust the amount of weight on your hips. This will fine tune your Easyrig VARIO 5 vest to a comfortable position.

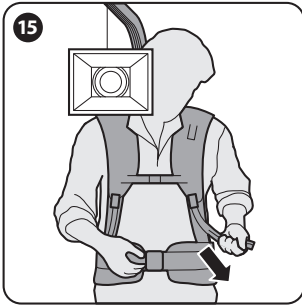

Fig. 15
Adjust the chest strap if necessary, but do not pull it too tight.

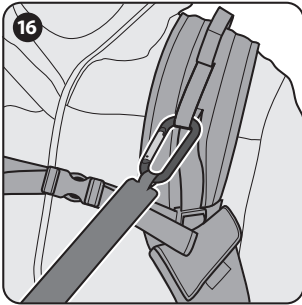
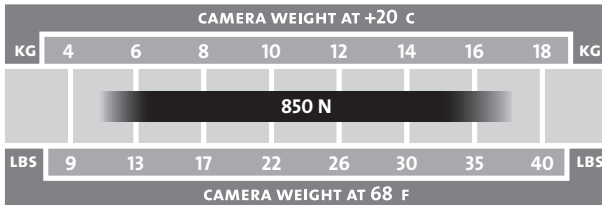

Fig. 16
Attach the safety line between your vest and your camera. Fasten one end to the loop on the left shoulder pad of the Easyrig VARIO 5 vest and the other through your camera handle. Your Easyrig VARIO 5 is now ready to be used.

Powered shock absorber range:



Safety precautions!



Always hold the camera when working with the Easyrig VARIO 5 and Always attach the safety strap between the camera and the Easyrig VARIO 5 vest shoulder loop.

Never undo the waist belt buckle when the camera is attached to the Easyrig VARIO 5! If the waist buckle is released while the camera is attached, the weight of the camera will pull the top of the Easyrig VARIO 5 down, and could cause you to lose control of the camera.

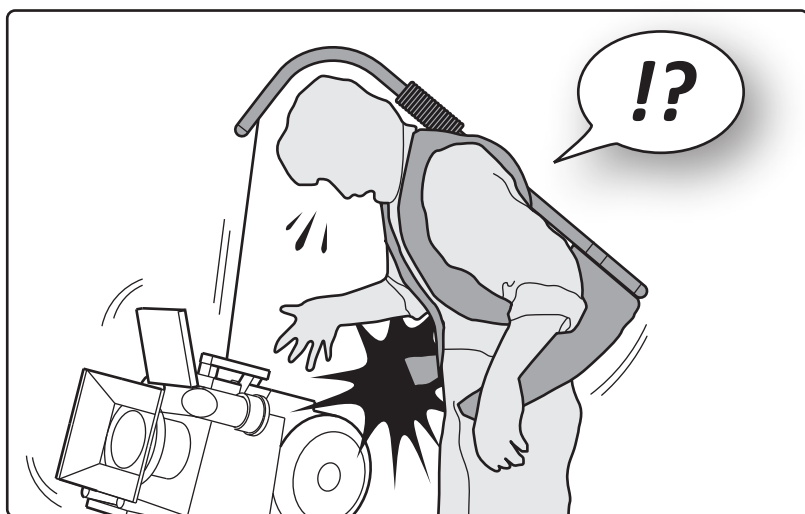

If you fall into water while wearing the Easyrig VARIO 5, it's important to get the equipment off quickly. Just release the waist, chest and shoulder strap buckles. Then slide the shoulder straps over and off of your arms.

Be especially careful when filming in rugged terrain. Make sure to wear appropriate comfortable shoes and clothing. If you work with the Easyrig VARIO 5 under special conditions, i.e. in a car, boat, plane or helicopter, always use a safety belt or harness.

Some practical advice

- Try to keep the camera as close to your body as possible, to avoid unnecessary strain on your back.
- When filming upwards, you might find it easier if you have the camera tucked under your arm.
- When filming at hip level during longer periods of time, rest the camera on the hip belt to increase stability.
- Use the Easyrig VARIO 5 for transporting your camera to and from the filming site.
- When folding your Easyrig VARIO 5 for storage, always make sure to tuck the upper part of the support arm inside the hip belt and fasten the buckle at the back of the hip belt. This will prevent the suspension line from wearing.
- If your Easyrig VARIO 5 will be inactive for more than a couple of months, make sure to store it standing up. This will keep the shock absorber gasket from drying out.

“Easyrig is an effective ergonomic relief aid for back and shoulders, intended for TV cameramen working with hand held cameras. A considerable load relief has been ascertained. The aid provides a good basis for improvement of back health. The results show that this aid can give long-term benefits in the form of improved back health, work effectiveness and picture quality.”

***Elisabeth Schell**, Authorized ergonomist and registered physiotherapist, Swedish Television*

Easyrig VARIO 5 limited Warranty

Manufacturer's products are warranted to be free from defects caused by faulty materials or workmanship for a period of two years from the date of purchase. The liability of the Manufacturer under this warranty is limited to repairing, replacing, or at its option issuing credit for any of its products which are returned by purchaser during such period provided, however, that:

- A. Warranty card is properly filled out and returned to Manufacturer within 30 days of purchase.
- B. Defective merchandise is returned to Manufacturer accompanied by a report of findings indicating the basis of/for rejection and with transportation charges paid by the purchaser.
- C. That such defects exist and have not been caused by abuse, misuse, neglect, improper installation or assembly, repair, alteration or accident.

In no event shall Manufacturer be liable for collateral or consequential damages of any nature. This warranty is in lieu of all other warranties expressed or implied.

Easyrig VARIO 5 Warranty Information Card

Registration of your newly bought Easyrig can also be done on our website www.easyrig.com.

[please fill in and mail within 30 days of purchase]

Name Title.....

Company Type of business

Address.....

City Postal code

Country.....

Phone Fax

E-mail.....

Easyrig serial No

Purchase location/company Date

Please send to: Easyrig AB
Anumark 231
S-905 95 Umeå
Sweden

or fax to: +46 90 77 60 01

Thank you!